



## Features

- ✧ Energy saving more than 50%.
- ✧ LED light environmental protection and energy saving without UV radiation.
- ✧ High efficiency (90%) constant current driver, with heat protection system.
- ✧ With high light through PC cover.
- ✧ Special light mix design looked from the surface.
- ✧ Soft surface when lighting.
- ✧ No fluorescent flickering.
- ✧ No hazard of mercury or lead entering environment.
- ✧ *Two years warranty*

## Typical Applications

- ✧ Landscape Accent
- ✧ Architectural Lighting
- ✧ Display Case Accent
- ✧ Artwork Lighting
- ✧ Mood Lighting
- ✧ Home Indoor lighting

## 3 Feet (908mm) Tube Light

Part No.	Input Voltage	CCT	Luminous flux	Flux at 1m	Power Factor	Working temperature	Working moisture	CRI
EL-T8-12W2D-RB-30	AC100-240V	3000K±175	800-900lm	140 lux	>85	-20°C -50°C	10%-90%	>75%
EL-T8-12W2D-RE-40		4000K±400	900-1000lm	145 lux	>85			
EL-T8-12W2D-RA-57		5700K±570	950-1050lm	150 lux	>85			

## Mechanical Dimensions:

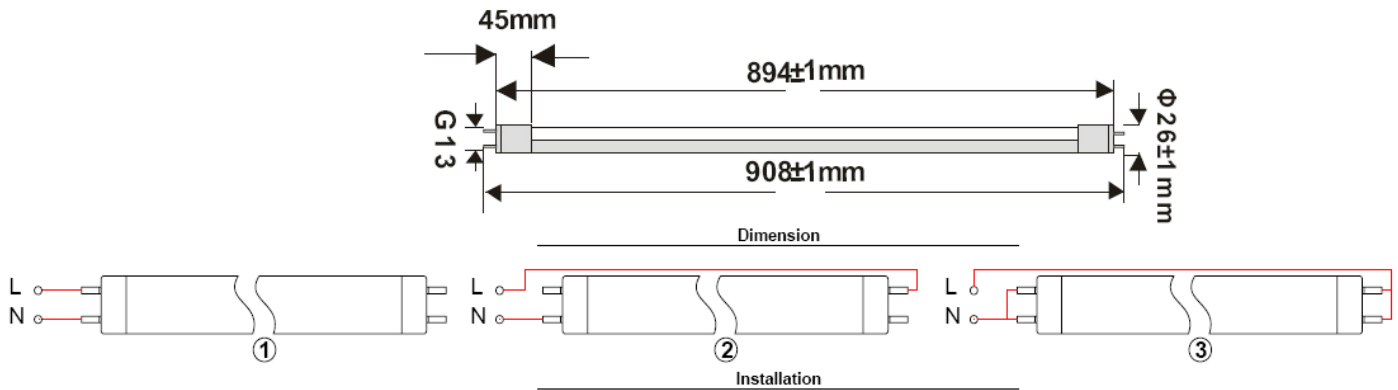

## Viewing Angle:

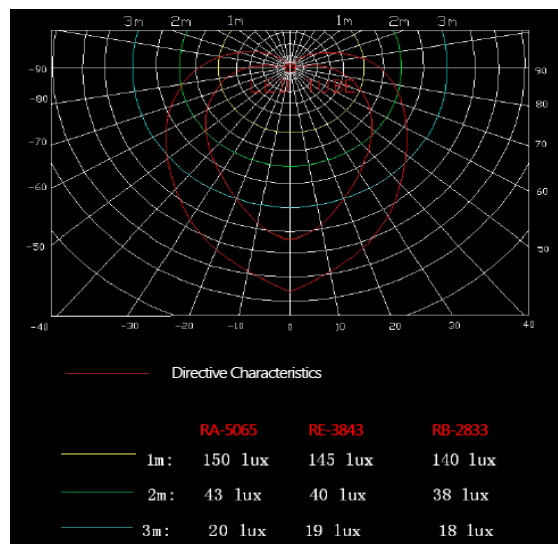
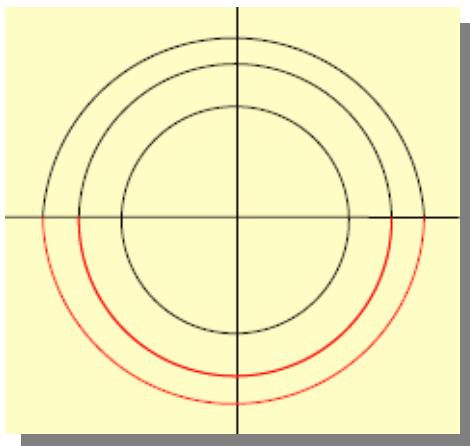

## Illuminance Maintenance:

Test Conditions:

TA=25°C

RH=65%

Light work lasting

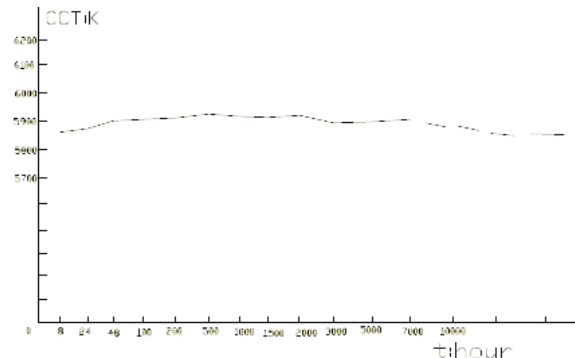
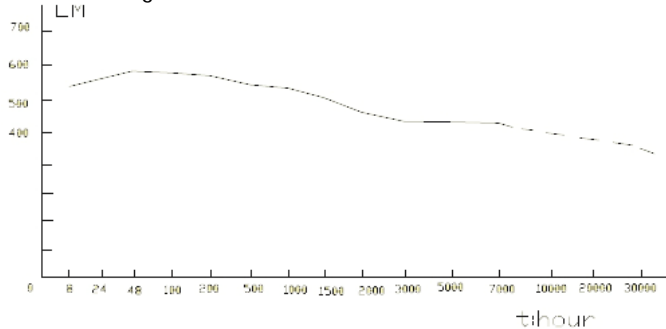

**Elite Enterprises (H.K.) Co., Ltd.**

Flat 707, 7/F., Nanyang Plaza, 57 Hung To Road, Kwun Tong, H.K.

Tel: (852) 2723-3122 Fax: (852) 2723-3990

www.elitelighting.com.hk info@elite-ent.com.hk

Ver 1.2 Page: 2/3

## The Relative Intensity vs. Wavelength:

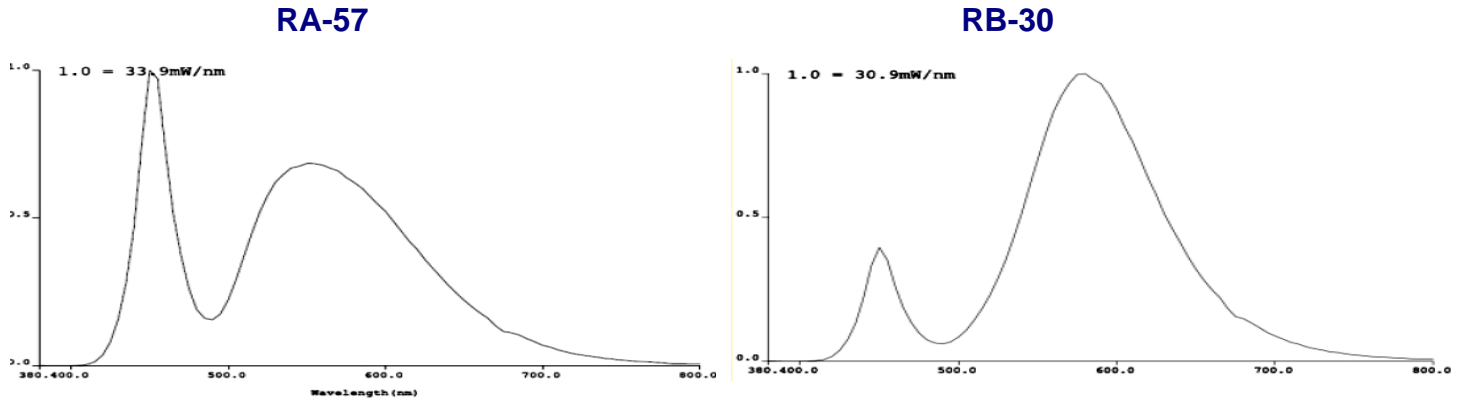

## Package Size:

- Carton Dimension: L936 x W220 x H190 mm
- Weight: 7.3 kg / box
- QTY.: 20 pcs / box

## Instructions and Attentions:

- Cut off the power supply before installation.
- No starter, ballast, or electronic switch is required.
- Please install lamp stand and T8 lamp holder first with the same length.
- Lamp working voltage is AC 220V.
- Please connect the two wire terminals located at the side of the lamp to the electricity L and N respectively.

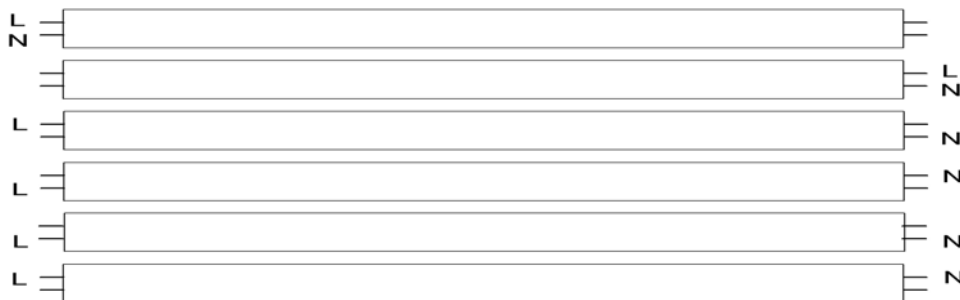

### Elite Enterprises (H.K.) Co., Ltd.

Flat 707, 7/F., Nanyang Plaza, 57 Hung To Road, Kwun Tong, H.K.

Tel: (852) 2723-3122 Fax: (852) 2723-3990

www.elitelighting.com.hk info@elite-ent.com.hk

Ver 1.2 Page: 3/3